



A3 Server Installation Guide

Document Version 0.1

Jan 2018

© Copyright Bitmaintech Pte.Ltd. 2007 – 2016. All rights reserved.

Bitmaintech Pte.Ltd. (Bitmain) reserves the right to make corrections, modifications, enhancements, improvements, and other changes to its products and services at any time and to discontinue any product or service without notice.

Customers should obtain the latest relevant information before placing orders and should verify that such information is current and complete. All products are sold subject to Bitmain's terms and conditions of sale supplied at the time of order acknowledgment.

Bitmain warrants performance of its products to the specifications applicable at the time of sale in accordance with Bitmain's standard warranty. Testing and other quality control techniques are used to the extent Bitmain

deems necessary to support this warranty. Except where mandated by government requirements, testing of all parameters of each product is not necessarily performed.

Bitmain assumes no liability for third-party applications assistance. Customers are responsible for their products and applications using Bitmain components. To minimize the risks associated with customer products and applications, customers should provide adequate design and operating safeguards.

Bitmain does not warrant or represent that any license, either express or implied, is granted under any Bitmain patent right, copyright or other Bitmain intellectual property right relating to any combination, machine, or process in which Bitmain products or services are used. Information published by Bitmain regarding third-party products or services does not constitute a license from Bitmain to use such products or services or a warranty or endorsement thereof. Use of such information may require a license from a third party under the patents or other intellectual property of the third party, or a license from Bitmain under the patents or other intellectual property of Bitmain.

Resale of Bitmain products or services with statements different from or beyond the parameters stated by Bitmain for that product or service voids all express and any implied warranties for the associated Bitmain product or service and is an unfair and deceptive business practice. Bitmain is not responsible or liable for any such statements.

All company and brand products and service names are trademarks or registered trademarks of their respective holders.

All text and figures included in this publication are the exclusive property of Bitmaintech Pte.Ltd. (Bitmain), and may not be copied, reproduced, or used in any way without the express written permission of Bitmain. Information in this document is subject to change without notice and does not represent a commitment on the part of Bitmain. Although the information in this document has been carefully reviewed, Bitmain does not warrant it to be free of errors or omissions. Bitmain reserves the right to make corrections, updates, revisions or changes to the information in this document.

Bitmaintech Pte. Ltd.

Tel:+86-400-890-8855

www.bitmain.com

Table of Contents

1. Overview	4
1.1 A3 Server Components.....	5
1.2 Specification	6
2. Connecting the Power Supply	7
3. Setting Up the Server	9
4. Configuring the Server.....	11
4.1 Setting Up the Pool.....	11
4.2 Modifying the Frequency	12
5. Monitoring Your Server	13
6. Administering Your Server	14
6.1 Checking Your Firmware Version	14
6.2 Upgrading Your System	14
6.3 Modifying Your Password.....	16
6.4 Restoring Initial Settings.....	16

1. Overview

The A3 server is Bitmain's newest version in the A3 server series. It boasts a state-of-the-art BM1720 custom-made chip using 28nm technology. All A3 servers are tested and configured prior to shipping to ensure easy set up.



Power supply unit is **not included**. Please provide your own ATX power supply.

1.1 A3 Server Components

The A3 server main components and controller front panel are shown in the following figure:

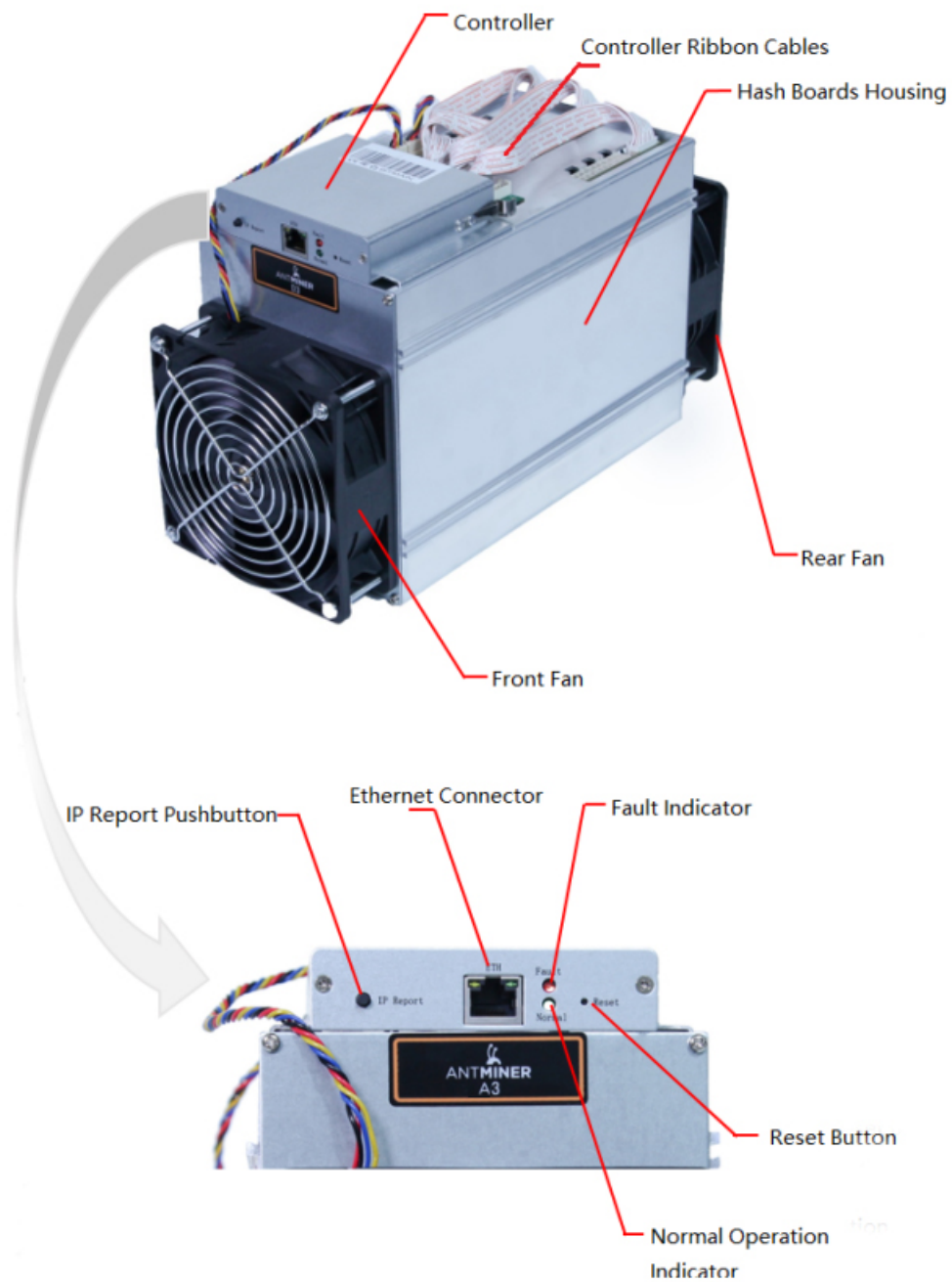

1.2 Specification

Hash Rate	815 GH/s±5%
Rated voltage	11.60 ~ 13.00V
Default Frequency	600M
Estimated wall outlet power consumption (with APW3, 93% efficiency, 25°C ambient temperature)	1275W + 7%
Estimated wall outlet power efficiency (with APW3, 93% efficiency, 25°C ambient temperature)	1.56mJ/MH + 7%
Dimensions (L x W x H)	321mm*125mm*208mm
Net weight without packaging	4.2kg
Operating ambient temperature	0 ~ 40°C



The server does not contain a DC/DC converter; therefore, higher input voltage will cause higher Mining efficiency.

2. Connecting the Power Supply

Ten PCI-e connectors are located at the top of the A3 server for connecting the PSU as follows:

- Nine PCI-e connectors for the hash boards. Each hash board has a set of three PCI-e connectors.
- One PCI-e connector located on the controller.



Each hashboard must be powered by the same PSU on both connectors to prevent possible damage and instability.

To connect the power supply:

1. Connect PSU power cable connectors to each of the nine PCI-e connectors on the top of the A3 server, ensuring that each hash board is powered by the same PSU.

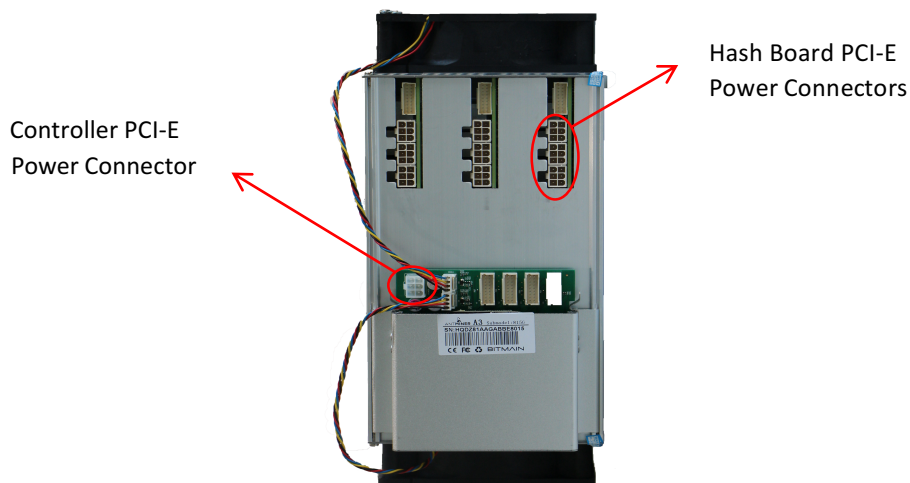

2. Connect a PSU power cable connector to the A3 server PCI-e connector on the controller.
3. Connect the network cable to the ETH port. (WIFI is unavailable for servers)
4. To power up your A3 server, connect the PSUs to the power wall outlet.



If you are using more than one PSU, power up the PSU connected to the controller AFTER you have powered up the other PSU(s).

2. Connecting the Power Supply

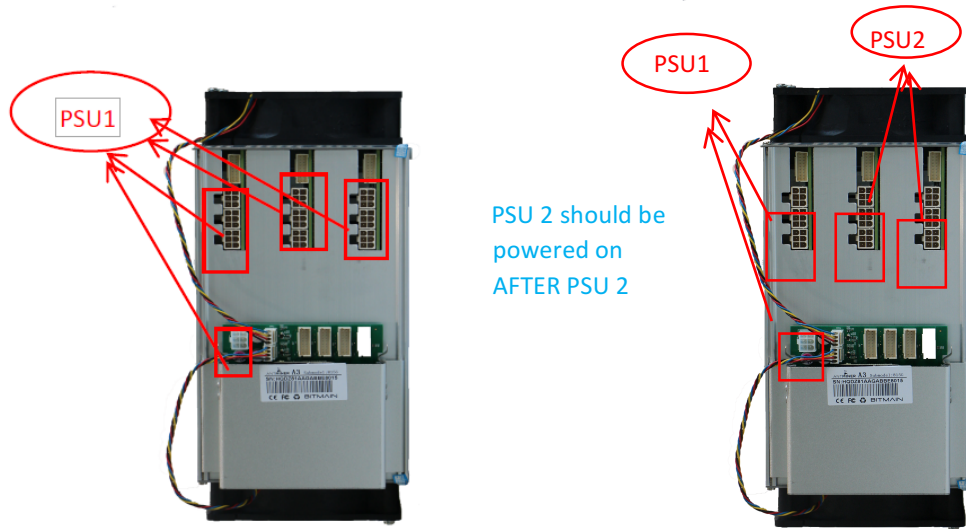

Figure 2-1. PCI-E Connectors - Correct Connection

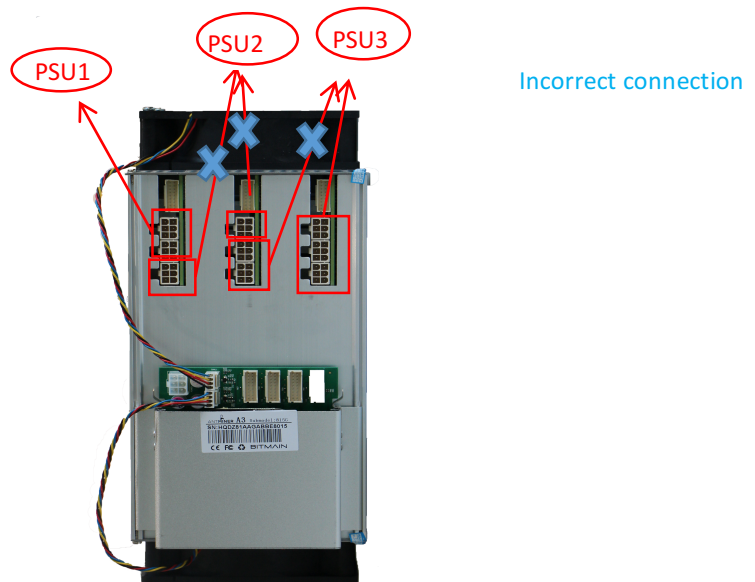

Figure 2-2. PCI-E Connectors - Incorrect Connection

3. Setting Up the Server

To set up the server:

The server starts up after powering up. You can find the server IP when the green light blinks. Please follow the steps below:

Download link:<https://pan.baidu.com/s/1cNp5DW>

Password:hkt2

- a. Click **Start**.

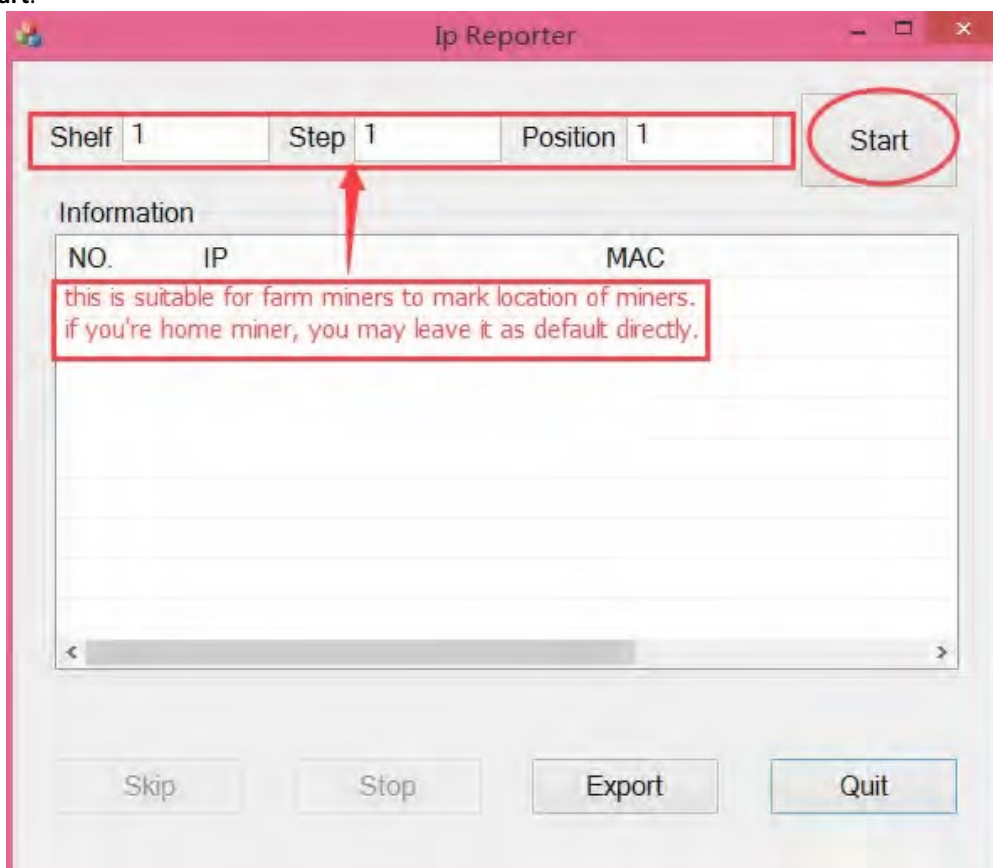

- b. On the controller board, click the IP Report button. Hold it down until it beeps (about 5 seconds)

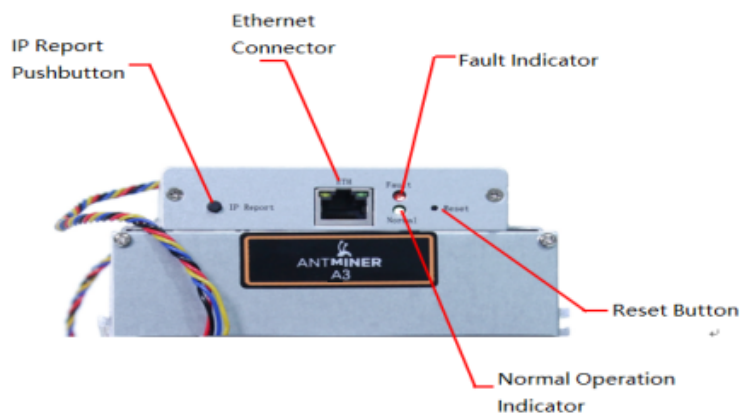

c. The IP address will be displayed in a window on your computer screen.

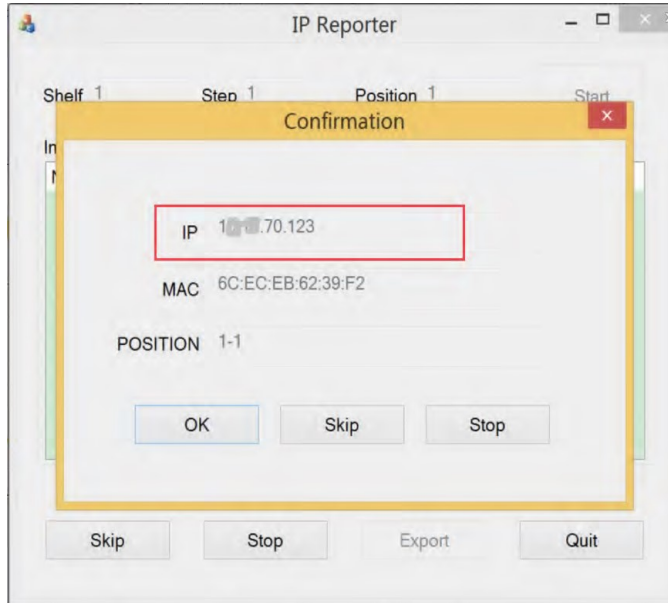

Note: The server and computer should be in the same network or you cannot receive information from the server.

3. In your web browser, enter the IP address provided.
4. Proceed to login using `root` for both the username and password.
5. In the Network section, you can assign a Static IP address (optional).
6. Click **Save & Apply**.

4. Configuring the Server

4.1 Setting Up the Pool

To configure the server:

1. click **General Settings**.
2. Set the options according to the following table:

Option	Description
Pool URL	Enter the URL of your desired pool. <div style="border: 1px solid black; padding: 10px;">  <p>The A3 server can be set up with three mining pools, with decreasing priority from the first pool (pool 1) to the third pool (pool 3). The pools with low priority will only be used if all higher priority pools are offline.</p> </div>
Worker	Your worker ID on the selected pool.
Password	The password for your selected worker.

3. Click **Save & Apply**. (The Screenshot below just for your reference to show the message, the message shows on your computer shall prevail.)

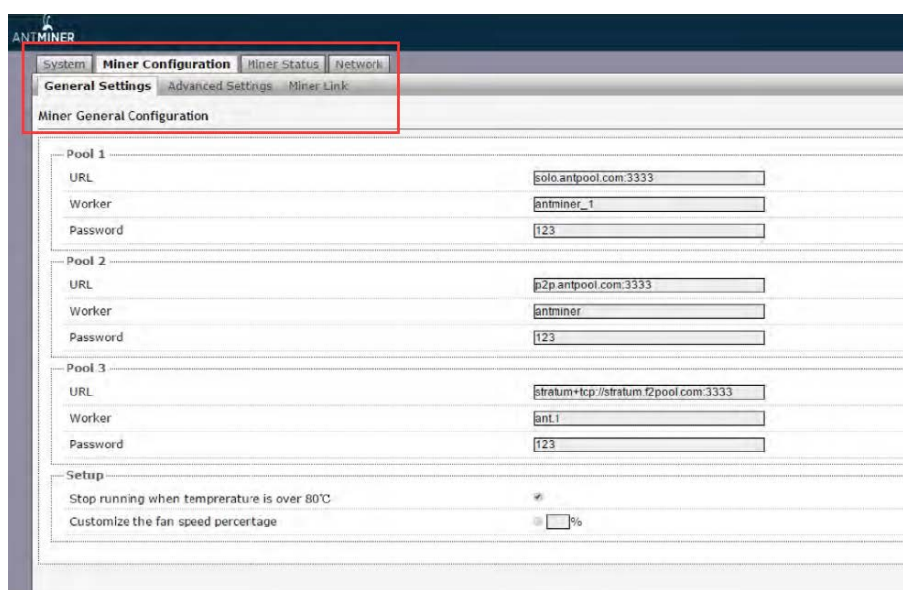

4.2 Modifying the Frequency

You are able to modify the frequency value through 'Configuration —>Advanced Settings'.



Bitmain recommend a default frequency of A3 server, and Overlocking the server will void the warranty immediately.

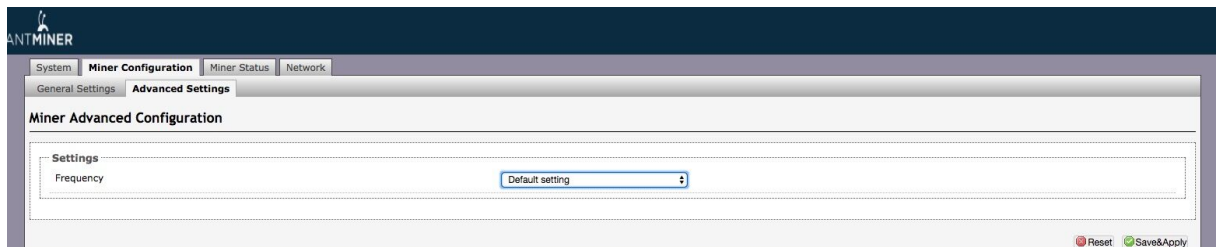

5. Monitoring Your Server

To check the operating status of your server:

1. Click the status marked below.
2. Monitor your server according to the descriptions in the following table:

Option	Description
ASIC#	Number of chips detected in the chain.
Frequency	ASIC frequency setting.
GH/S(RT)	Hash rate of each hash board (GH/s)
Temp(PCB)	Temperature of each hash board (°C).(Applied only to miner with fixed frequency)
Temp(Chip)	Temperature of the chips on each hash board (°C).
ASIC status	One of the following statuses will appear: <ul style="list-style-type: none"> ● O - indicates OK ● X - indicates error ● - - indicates dead

Screenshot of *Server Status* for A3

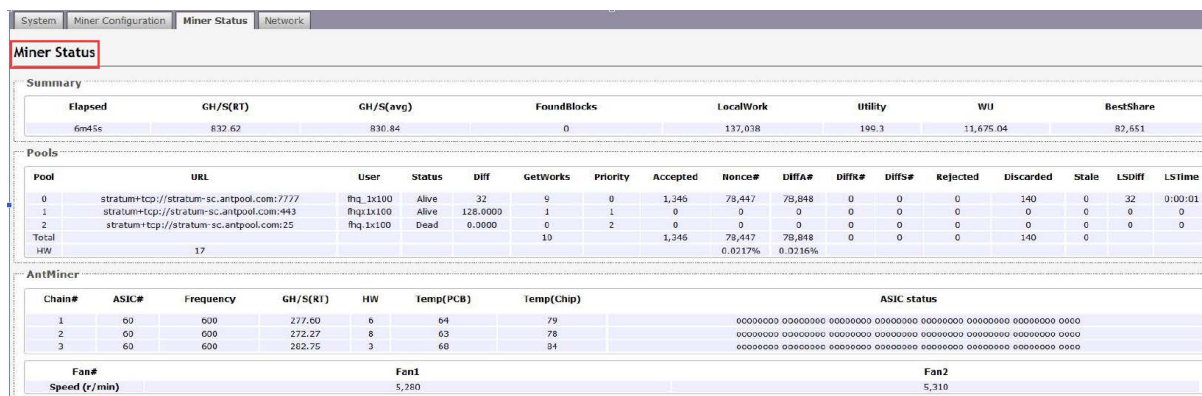

The screenshot shows the 'Miner Status' interface with the following data:

Miner Status																
Summary																
Elapsed	GH/S(RT)	GH/S(avg)	FoundBlocks	LocalWork	Utility	WU	BestShare									
6m45s	832.62	830.84	0	137,038	196.3	11,675.04	82,651									
Pools																
Pool	URL	User	Status	Diff	GetWorks	Priority	Accepted	Nonce#	DIFA#	DIFR#	DIFS#	Rejected	Discarded	Stale	LSD#	LSTime
0	stratum+tcp://stratum-sc.antpool.com:7777	fhq.1x100	Alive	32	9	0	1,345	78,447	78,848	0	0	0	140	0	32	0:00:01
1	stratum+tcp://stratum-sc.antpool.com:443	fhq.1x100	Alive	128.0000	1	1	0	0	0	0	0	0	0	0	0	0
2	stratum+tcp://stratum-sc.antpool.com:25	fhq.1x100	Dead	0.0000	0	2	0	0	0	0	0	0	0	0	0	0
Total					10		1,345	78,447	78,848	0	0	0	140	0		
HW	17							0.0217%	0.0216%							
AntMiner																
Chain#	ASIC#	Frequency	GH/S(RT)	HW	Temp(PCB)	Temp(Chip)	ASIC status									
1	60	600	277.60	6	64	79	00000000 00000000 00000000 00000000 00000000 00000000 00000000 0000									
2	60	600	272.27	8	63	78	00000000 00000000 00000000 00000000 00000000 00000000 00000000 0000									
3	60	600	262.75	3	60	84	00000000 00000000 00000000 00000000 00000000 00000000 00000000 0000									
Fan#				Fan1				Fan2								
Speed (r/min)				5,280				5,310								

 Note: The A3 server will stop running when the Temp(PCB) exceeds to 85°C, there will be an error message "Fatal Error: Temperature is too high!" shown in the bottom of kernel log page.

6. Administering Your Server

6.1 Checking Your Firmware Version

To check your firmware version:

1. In **System**, click the **Overview** tab.
2. **File System Version** displays the date of the firmware your server use.

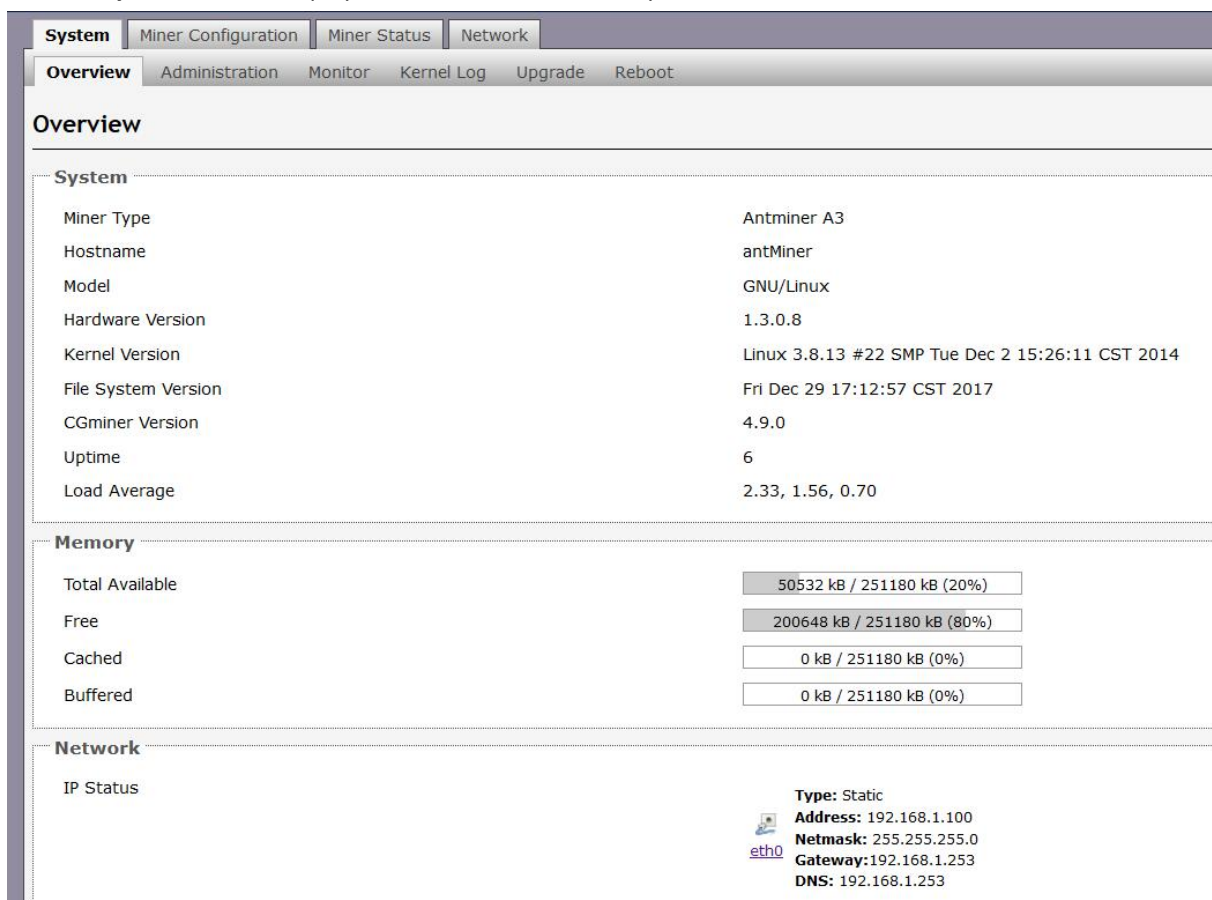

The screenshot shows the Antminer A3 web interface. The 'System' tab is selected, and the 'Overview' sub-tab is active. The 'System' section displays the following information:

Miner Type	Antminer A3
Hostname	antMiner
Model	GNU/Linux
Hardware Version	1.3.0.8
Kernel Version	Linux 3.8.13 #22 SMP Tue Dec 2 15:26:11 CST 2014
File System Version	Fri Dec 29 17:12:57 CST 2017
CGminer Version	4.9.0
Uptime	6
Load Average	2.33, 1.56, 0.70

The 'Memory' section shows the following status:

Total Available	50532 kB / 251180 kB (20%)
Free	200648 kB / 251180 kB (80%)
Cached	0 kB / 251180 kB (0%)
Buffered	0 kB / 251180 kB (0%)

The 'Network' section shows the IP Status for the eth0 interface:

IP Status	Type: Static
	Address: 192.168.1.100
	Netmask: 255.255.255.0
	Gateway: 192.168.1.253
	DNS: 192.168.1.253

6.2 Upgrading Your System



Make sure that the A3 server remains powered during the upgrade process. If power fails before the upgrade is completed, you will need to return it to Bitmain for repair.

To upgrade the server's firmware (the firmware can be employed universally for all A3)

1. In **System**, click **Upgrade**.

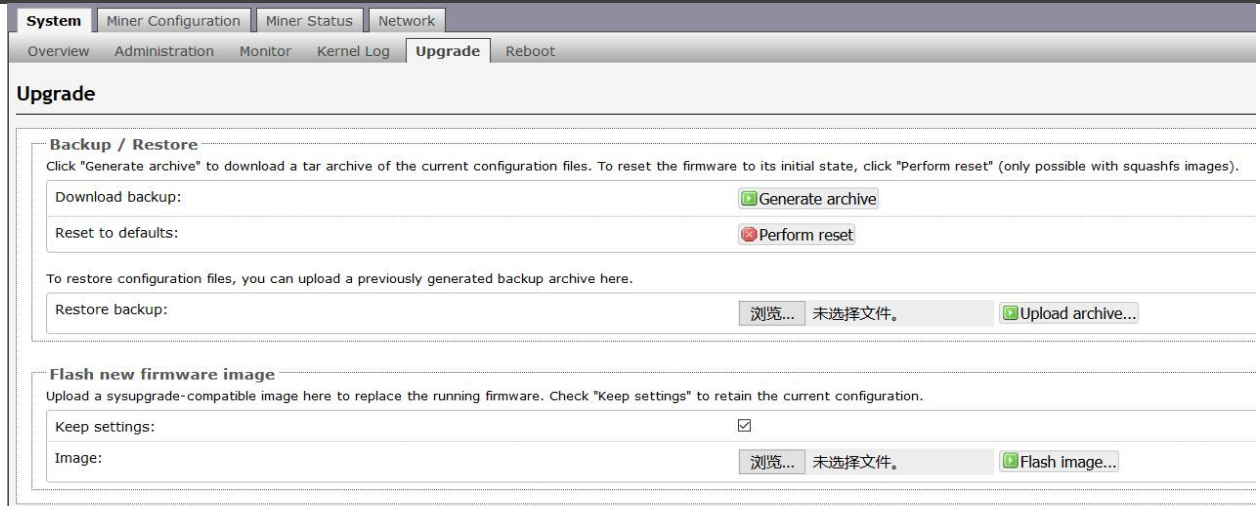

2. For **Keep Settings**:
 - Select the check box to keep your current settings (default).
 - Clear the check box to reset the server to default settings.
3. Click the (**Browse**) button and navigate to the upgrade file. Select the upgrade file, then click **Flash image**. A message appears notifying you if the A3 server firmware can be upgraded and if yes, will then proceed to flash the image. (Note: Please do not extract the update file and keep the power on during updating firmware or otherwise the server need to be returned to the factory to repair. And around two minutes will be needed to complete updating.)

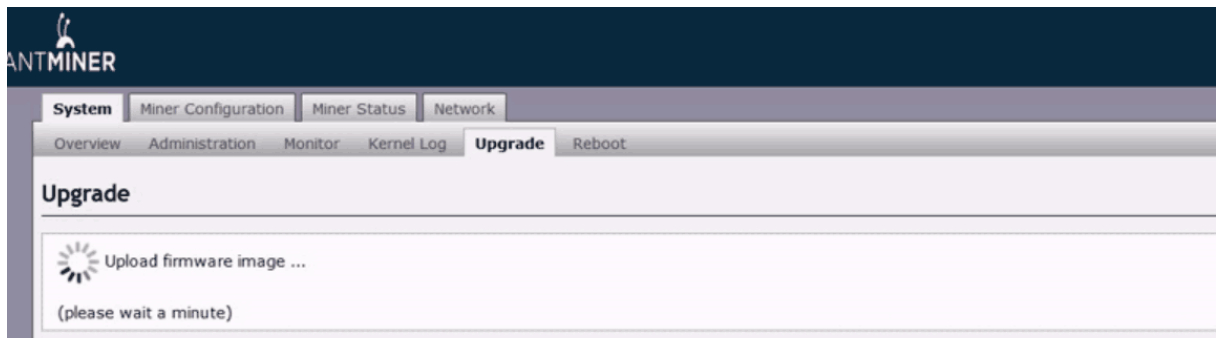

3. When the upgrade is completed successfully, the following message will appear: (Screenshot below of S9 server just for your reference to show the message, the message shows on your computer shall prevail.).

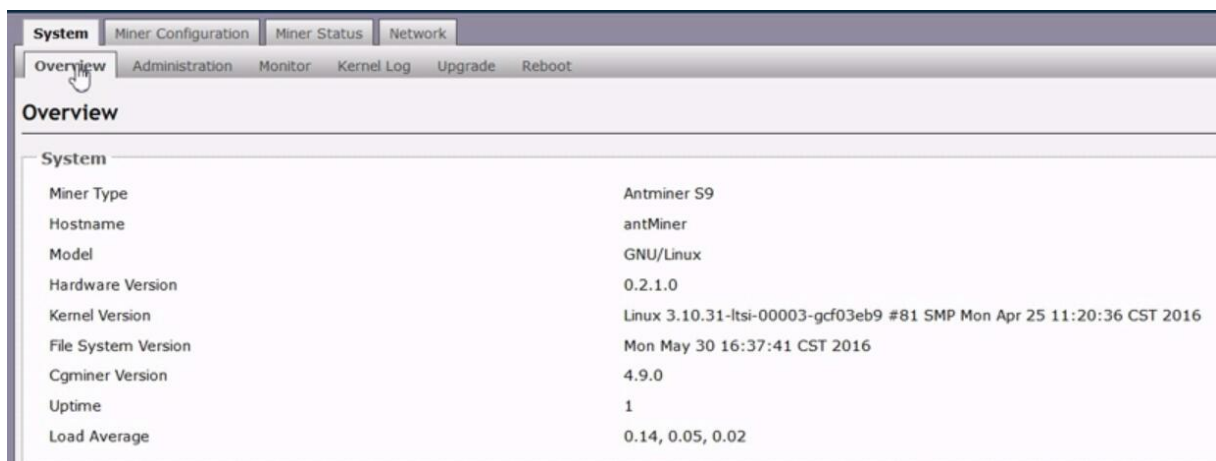

6.3 Modifying Your Password

To change your login password:

1. In **System**, click the **Administration** tab.
2. Set your new password, then click **Save & Apply**.

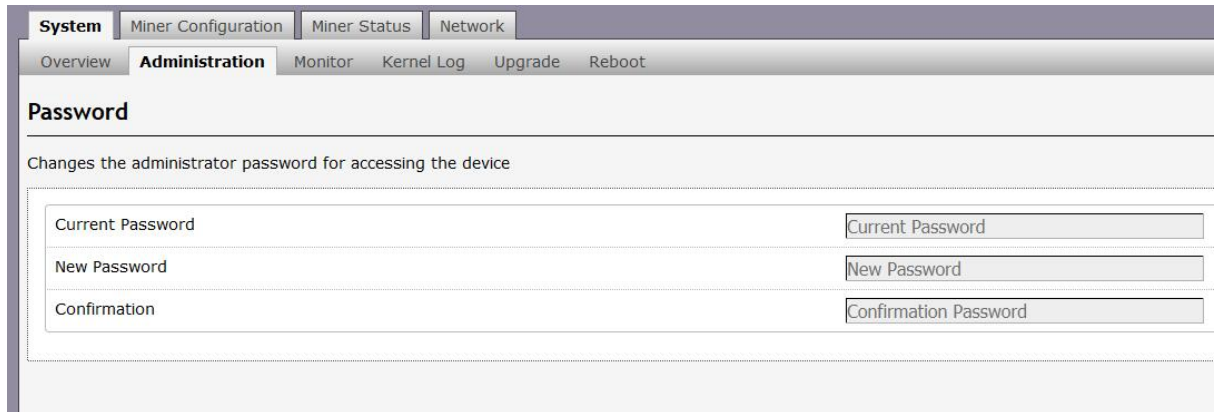

The screenshot shows the Antminer web interface. At the top, there are tabs for 'System', 'Miner Configuration', 'Miner Status', and 'Network'. Under 'System', there are sub-tabs for 'Overview', 'Administration', 'Monitor', 'Kernel Log', 'Upgrade', and 'Reboot'. The 'Administration' tab is selected, and the page title is 'Password'. Below the title, there is a description: 'Changes the administrator password for accessing the device'. The form contains three input fields: 'Current Password', 'New Password', and 'Confirmation'. Each field has a corresponding label on the right side of the form.

6.4 Restoring Initial Settings

To restore your initial settings, two methods below for your reference.

1. Turn on the server and let it run for 5 minutes.
2. On the controller front panel, press and hold the **Reset** button for 10 seconds.



Resetting your server will reboot it and restore its default settings. The red LED will automatically flash once every 15 seconds if the reset is operated successfully.

Regulation:

FCC Notice (FOR FCC CERTIFIED MODELS):

This device complies with part 15 of the FCC Rules. Operation is subject to the following two conditions: (1) This device may not cause harmful interference, and (2) this device must accept any interference received, including interference that may cause undesired operation.

Note:

This equipment has been tested and found to comply with the limits for a Class A digital device, pursuant to part 15 of the FCC Rules. These limits are designed to provide reasonable protection against harmful interference when the equipment is operated in a commercial environment. This equipment generates, uses, and can radiate radio frequency energy and, if not installed and used in accordance with the instruction manual, may cause harmful interference to radio communications. Operation of this equipment in a residential area is likely to cause harmful interference in which case the user will be required to correct the interference at his own expense.

EU WEEE: Disposal of Waste Equipment by Users in Private Household in the European Union



This symbol on the product or on its packaging indicates that this product must not be disposed of with your other household waste. Instead, it is your responsibility to dispose of your waste equipment by handing it over to a designated collection point for the recycling of waste electrical and electronic equipment. The separate collection and recycling of your waste equipment at the time of disposal will help to conserve natural resources and ensure that it is recycled in a manner that protects human health and the environment. For more information

about where you can drop off your waste equipment for recycling, please contact your local city office, your household waste disposal service or the shop where you purchased the product.

台灣 ROHS:

設備名稱: _____, 型號: _____						
單元	有害物質					
	鉛 (Pb)	汞 (Hg)	鎘 (Cd)	六價鉻 (Cr+6)	多溴聯苯 (PBB)	多溴二苯醚 (PBDE)
外殼	○	○	○	○	○	○
電路板組件	—	○	○	○	○	○
其他線材	—	○	○	○	○	○

備考 1. “超出 0.1 wt %” 及 “超出 0.01 wt %” 係指限用物質之百分比含量超出百分比含量基準值。
 備考 2. “○” 係指該項限用物質之百分比含量未超出百分比含量基準值。
 備考 3. “—” 係指該項限用物質為排除項目